



Honeywell

Installation Guide

VisionPRO® TH8000 Series

Touch-screen Programmable Thermostat

This manual covers the following models

- **TH8321U1097:** For up to 3 Heat/2 Cool heat pump or up to 2 Heat/2 Cool conventional systems with dehumidification, humidification, or ventilation
(Pull thermostat from wallplate and turn over to find model number)

Must be installed by a trained, experienced technician

- Read these instructions carefully. Failure to follow these instructions can damage the product or cause a hazardous condition.



CAUTION: ELECTRICAL HAZARD

Can cause electrical shock or equipment damage. Disconnect power before beginning installation.



MERCURY NOTICE

If this product is replacing a control that contains mercury in a sealed tube, do not place the old control in the trash. Contact your local waste management authority for instructions regarding recycling and proper disposal.

This thermostat contains a Lithium battery which may contain Perchlorate material. Perchlorate Material—special handling may apply, See www.dtsc.ca.gov/hazardouswaste/perchlorate

Need Help?

For assistance with this product please visit <http://customer.honeywell.com>
or call Honeywell Customer Care toll-free at 1-800-468-1502



Wallplate installation

1. Separate wallplate from thermostat.
2. Mount wallplate as shown below.

Grasp top and bottom of wallplate and pull to remove from thermostat.

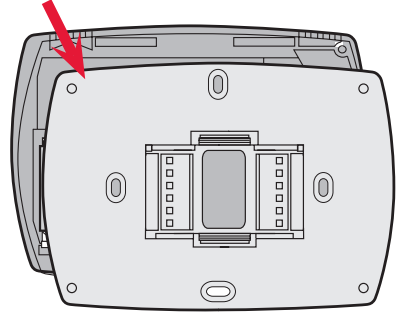

Drill 3/16" holes for drywall.
Drill 7/32" holes for plaster.

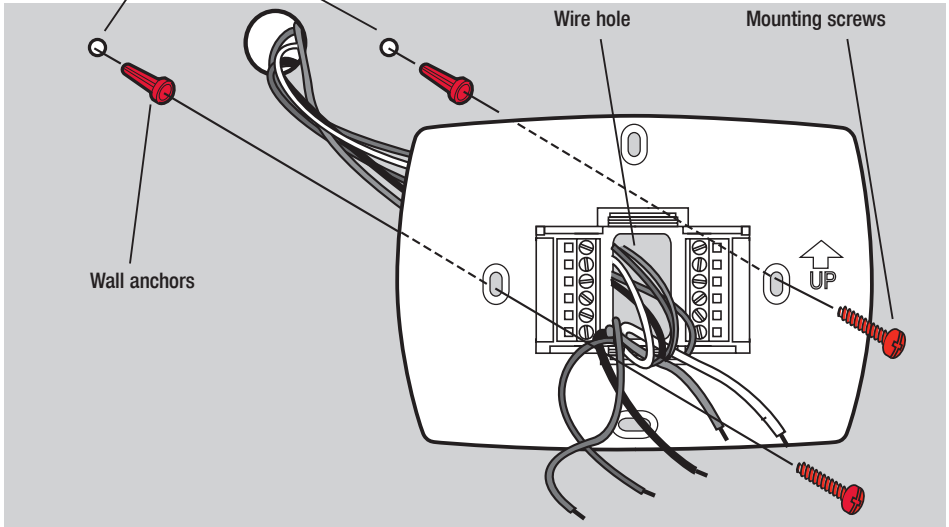

ENGLISH

Power options

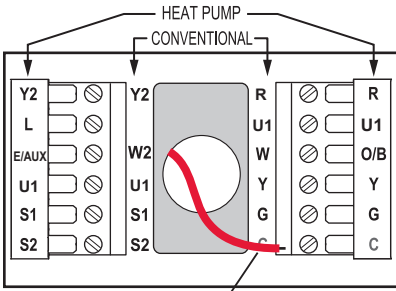

For 24VAC primary power, connect common side of transformer to “C” terminal.

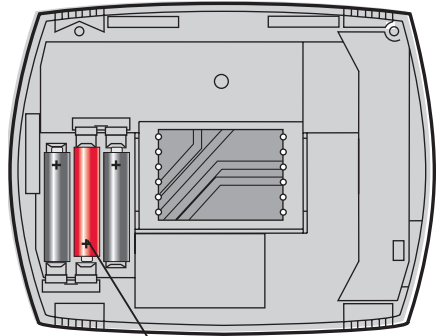

Insert supplied batteries for primary or backup power.

MCR29723

Wiring

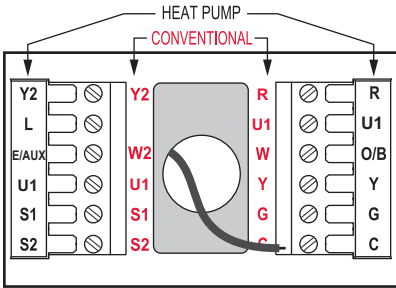

Push excess wire back into the wall opening. Plug wall opening with non-flammable insulation.

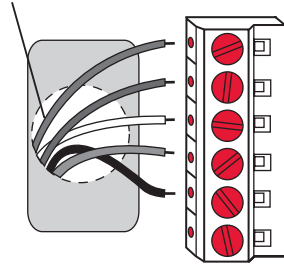

MCR29724

Terminal Designations

Conventional Terminal Letters:

- R** System power. Connect to secondary side of system transformer.
- C** Common wire from secondary side of transformer.
- W** 1st stage heat relay.
- W2** 2nd stage heat relay.
- Y** 1st stage compressor contactor.
- Y2** 2nd stage compressor contactor.
- G** Fan relay.
- S1/S2** Optional outdoor/remote/discharge sensor.
- U1/U1** Optional IAQ device

Heat Pump Terminal Letters:

- R** System power. Connect to secondary side of system transformer.
- C** Common wire from secondary side of system transformer.
- Y** 1st stage compressor contactor.
- Y2** 2nd stage compressor contactor.
- E/Aux** Auxiliary/Emergency heat relay.
- G** Fan relay.
- L** Heat pump reset (powered continuously when System is set to Em Heat; system monitor when set to Heat, Cool or Off).
- O/B** Changeover valve for heat pumps.
- S1/S2** Optional outdoor/remote/discharge sensor.
- U1/U1** Optional IAQ device

Wiring

Wiring guide—conventional systems

1H/1C System (1 transformer)

R	Power [1, 6]
W	Heat relay
Y	Compressor contactor
G	Fan relay
C	24VAC common [2]
S1/S2	Optional outdoor/remote/discharge sensor
U1/U1	Optional IAQ relay

Heat Only System

R	Power [1]
W	Heat relay
C	24VAC common [2]
S1/S2	Optional outdoor/remote/discharge sensor
U1/U1	Optional IAQ relay

Heat Only System (Series 20)

R	Series 20 valve terminal “R” [1]
W	Series 20 valve terminal “B”
Y	Series 20 valve terminal “W”
C	24VAC common [2]
S1/S2	Optional outdoor/remote/discharge sensor
U1/U1	Optional IAQ relay

2H/2C System (1 transformer)

Y2	Cool relay 2
W2	Heat relay 2
R	Power [1, 6]
W	Heat relay 1
Y	Cool relay 1
G	Fan relay
C	24VAC common [2]
S1/S2	Optional outdoor/remote/discharge sensor
U1/U1	Optional IAQ relay

Heat Only System With Fan

R	Power [1, 6]
W	Heat relay
G	Fan relay
C	24VAC common [2]
S1/S2	Optional outdoor/remote/discharge sensor
U1/U1	Optional IAQ relay

Cool Only System

R	Power [1]
Y	Compressor contactor
G	Fan relay
C	24VAC common [2]
S1/S2	Optional outdoor/remote/discharge sensor
U1/U1	Optional IAQ relay

See [notes] below

- [1] Power supply. Provide disconnect means and overload protection as required.
- [2] Optional 24VAC common connection.
- [6] Only works with single transformer systems.

Wiring

Wiring guide—heat pump systems

1H/1C Heat Pump (no auxiliary heat)

R	Power [1]
O/B	Changeover valve [3]
Y	Compressor relay
G	Fan relay
C	24VAC common [2]
S1/S2	Optional outdoor/remote/discharge sensor
U1/U1	Optional IAQ relay

2H/1C Heat Pump (with auxiliary heat)

L	Equipment monitor [4, 5]
E/Aux	Auxiliary/emergency heat relay
R	Power [1]
O/B	Changeover valve [3]
Y	Compressor relay
G	Fan relay
C	24VAC common [2, 4]
S1/S2	Optional outdoor/remote/discharge sensor
U1/U1	Optional IAQ relay

2H/2C Heat Pump (no auxiliary heat)

Y2	Compressor 2 relay
R	Power [1]
O/B	Changeover valve [3]
Y	Compressor 1 relay
G	Fan relay
C	24VAC common [2]
S1/S2	Optional outdoor/remote/discharge sensor
U1/U1	Optional IAQ relay

3H/2C Heat Pump (with auxiliary heat)

Y2	Compressor 2 relay
L	Equipment monitor [4, 5]
E/Aux	Auxiliary/Emergency heat relay
R	Power [1]
O/B	Changeover valve [3]
Y	Compressor 1 relay
G	Fan relay
C	24VAC common [2, 4]
S1/S2	Optional outdoor/remote/discharge sensor
U1/U1	Optional IAQ relay

Wiring guide—humidification systems

Steam humidifier (or any humidifier with its own transformer)

R	Power [1]
U1	Humidifier relay [7]
U1	Humidifier relay [7]

Bypass, flow-through humidifier (or any humidifier that uses the system transformer)

R	Power [1]
U1	Field jumper R to U1 [7]
U1	Humidifier relay [7]

Wiring guide—dehumidification systems

Whole house dehumidifier

R	Power [1]
U1	Dehumidifier relay [7]
U1	Dehumidifier relay [7]

A/C with low-speed fan

R	Power [1]
U1	Field jumper R to U1 [7]
U1	Dehumidifier relay [8]

Wiring guide—ventilation systems

Whole house powered ventilator

R	Power [1]
U1	Ventilator relay [7]
U1	Ventilator relay [7]

Non-powered ventilator

R	Power [1]
U1	Field jumper R to U1 [7]
U1	Ventilator relay

See [notes] below

- [1] Power supply. Provide disconnect means and overload protection as required.
- [2] Optional 24VAC common connection.
- [3] **O/B** set to control as either **O** or **B** in installer setup.
- [4] If **L** terminal is used, 24VAC common (terminal **C**) must be connected.
- [5] Heat pump reset (powered continuously when thermostat is set to Em. Heat; system monitor when set to Heat, Cool, or Off).
- [7] Terminals are normally open dry contacts.
- [8] Equipment must include dehumidification terminal for low-speed fan.

Remove tab and mount thermostat

Remove tab.

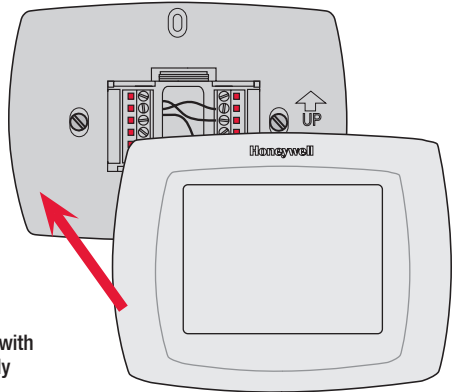
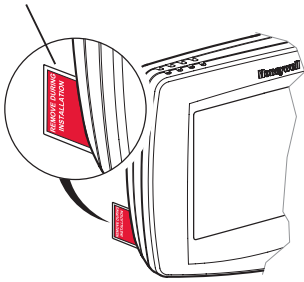

Align pins on back of thermostat with slots in wallplate, then push gently until thermostat snaps into place.

MCR29484

Set date and time

Press ▲▼
to set date

Press ▲▼
to set month

Press ▲▼
to set year

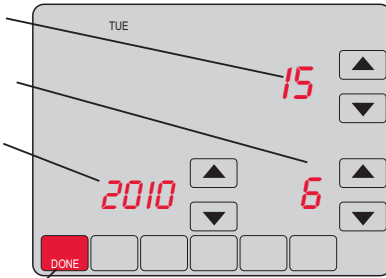

Press **DONE** to save changes.

Press ▲▼
to set time

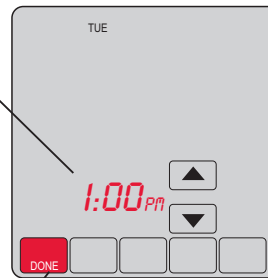

Press **DONE** to save and exit.

MCR29746

Installer setup

1 Press **SYSTEM**

2 Press and hold for 5 seconds

3 Change settings (see p. 7-9)

Press **DONE** to save & exit

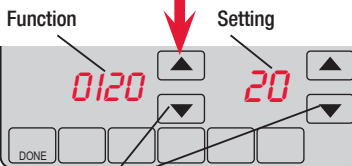
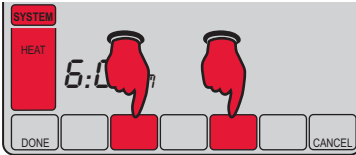
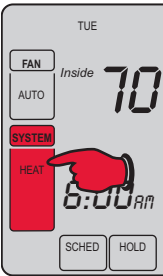

Press ▲▼ to change

MCR29745

Installer setup

Setup functions	Settings & Options (factory default in bold)
0120 Year (first two digits)	20 (2000-2099) 21 (2101-2178)
0130 Year (second two digits)	10 (2010) [Other options: 00-99]
0140 Month	6 [Other options: 1-12]
0150 Date	15 [Other options: 1-31]
0160 Schedule format	4 7-day programming 0 Non-programmable
0165 Restore energy saving	0 No 1 Yes
0170 System type	1 1 heat/1 cool conventional 2 1 heat/1 cool heat pump (no aux. heat) 3 Heat only (2-wire systems) 4 Heat only with fan 5 Hot water Series 20 system (power to open & close zone valves/normally open zone valves) 6 Cool only 7 2 heat/1 cool heat pump (with aux. heat) 8 2 heat/2 cool multistage conventional 9 2 heat/1 cool multistage conventional 10 1 heat/2 cool multistage conventional 11 2 heat/2 cool heat pump (no aux. heat) 12 3 heat/2 cool heat pump (with aux. heat)
0173 Heat Pump Type	0 Air to Air heat pump 1 Geothermal heat pump
0180 Fan control (heating)	0 Gas/Oil heat (equipment controls heating fan) 1 Electric furnace (thermostat controls heating fan)
0190 Changeover valve (O/B terminal)	0 O/B terminal controls valve in cooling 1 O/B terminal controls valve in heating
0200 Auxiliary heat	0 Electric backup heat 1 Fossil fuel backup heat
0210 External fossil fuel kit	1 External fossil fuel kit controls backup heat 0 Thermostat controls backup heat (outdoor sensor required)
0220 1st stage com- pressor cycle rate	3 Recommended for most compressors [Other options: 1, 2, 4, 5 or 6 CPH]
0230 2nd stage com- pressor cycle rate	3 Recommended for most compressors [Other options: 1, 2, 4, 5 or 6 CPH]
0240 1st stage heat cycle rate (CPH= cycles per hour)	5 Gas or oil furnaces of less than 90% efficiency 1 Steam or gravity systems 3 Hot water systems & furnaces of 90%+ efficiency 9 Electric furnaces [Other options: 2, 4, 6, 7, 8, 10, 11, 12 CPH]
0250 2nd stage heat cycle rate (CPH)	5 Gas or oil furnaces of less than 90% efficiency 1 Steam or gravity systems 3 Hot water systems & furnaces of 90%+ efficiency 9 Electric furnaces [Other options: 2, 4, 6, 7, 8, 10, 11, 12 CPH]
0260 3rd stage heat cycle rate (CPH)	9 Electric auxiliary heat or electric furnaces 1 Steam or gravity systems 3 Hot water systems & furnaces of 90%+ efficiency 5 Gas or oil furnaces of less than 90% efficiency [Other options: 2, 4, 6, 7, 8, 10, 11, 12 CPH]

Continued on next page

Installer setup

Setup functions		Settings & Options (factory default in bold)	
0280	Backlight	0	Backlight on for approx. 8 seconds after keypress
		1	Backlight always on low intensity, full bright after keypress (requires 24VAC connection)
0300	Manual/Auto changeover	0	Manual changeover (Heat/Cool/Off)
		1	Automatic changeover (Heat/Cool/Auto/Off)
0310	Auto changeover deadband	3	Heat/cool temperature 3°F apart (1.5°C) ** See page 11
			[Other options: 2-9 (2°F to 9°F/1°C to 5°C)]
0320	Temperature display	0	Fahrenheit
		1	Celsius
0330	Daylight savings	2	Auto-change to daylight saving time
		0	Daylight saving time is turned off
0340	Remote sensor	0	No remote sensor
		1	Outdoor sensor (display only)
		2	Outdoor sensor for control (select lockouts and frost protection) ** See page 11
		3	Indoor sensor
		4	Discharge air sensor (Required for Desert humidity control) ** See page 11
0345	Dual Fuel Heat Pump Control **	1	Droop Control
		0	No droop control
		2	Droop control with aux heat lockout
0346	Dual fuel heat pump upstage to furnace timer **	1	1 hour
		0	Off
			[Other options: 0.5, 1.5, 2-6, 8, 10, 12, 14, 16 hours]
0347	Droop temperature	2	2°F (1°C)
			[Other options: 2-5 (2°F to 5°F/1°C to 2.5°C)]
0350	Heat pump compressor lockout	0	No heat pump compressor lockout
			[Other options: 5-60°F (-15°C to 15.5°C)] ** See page 11
0360	Heat pump auxiliary lockout	0	No heat pump auxiliary lockout
			[Other options: 5-65°F (-15°C to 18.5°C)] ** See page 11
0371	Indoor Air Quality device on U1/U1	0	None
		1	Humidification
		2	Dehumidification
		3	Ventilation
0372	Humidification Control	0	Off
		1	Humidify with no frost protection
		3	Humidify with frost protection
		8	Desert humidity control in heat, off, or cool; DATS required
0374	Hum fan action	0	Humidify only while fan is on
		1	Humidifier forces fan on
		2	Humidify only when heat it on
		3	Humidifier operates independent of fan
0379	Dehumidification Control	0	None
		1	Air conditioning with low speed fan
		3	Whole house dehumidification
0380	Dehumidify with air conditioner	0	No dehumidification control
		1	Thermostat controls dehumidification with air conditioner high speed fan ** See page 11
0383	Over cooling limit	3	3°F (1.5°C)
			[Other options: 1-2 (1°F to 2°F/5°C to 1°C)]
0384	Dehumidification fan control	0	Fan turns on with dehumidifier
		1	Dehumidifier operates independent of fan
0386	Whole house dehumidification lockout	0	Off
		1	On

**** See pages 11-12**
Continued on next page

Installer setup

Setup functions	Settings & Options (factory default in bold)
0390 Dehumidification Away Mode	0 No 1 Yes
0391 Dehumidification Away Mode Fan Setting	0 Fan auto 1 Fan on 2 Fan circulate
0392 Dehum. Away Mode Low Limit Temperature Setting	76 Low limit temperature 76°F (24°C) [Other options: 70°F to 80°F (21°C to 27°C)]
0393 Dehum. away mode temp. setting	85 Low limit away temperature 85°F (29°C) [Other options: 70°F to 99°F (21°C to 37°C)]
0394 Dehum. Away Mode Dehum. Setting	65 Away humidity level 65% [Other options: 40% to 70%]
0400 Ventilation control	0 No ventilation 1 Vent on during all periods 2 Vent off during sleep period 3 Vent on during all periods with lockouts 4 Vent off during sleep period with lockouts
0401 Number of bedrooms	2 Two bedrooms [Other options: 1 to 6]
0402 Size of home	10 1,000 square feet [Other options: 11 to 50 (1,100 to 5,000 square feet)]
0403 Ventilation level	160 CFM (cubic feet per minute) [Other options: (30 to 195 CFM)]
0404 Max. ventilation limit	50 50% ventilation limit [Other options: 30% to 60% or 100%] P Meets ASHRAE 62.2 standard F Does not meet ASHRAE 62.2 standard
0405 Ventilation fan action	1 Ventilation on forces fan on 2 Ventilation does not force fan on
0430 Ventilation lockout	0 Off 1 Lockout for high temperatures ** See page 11 2 Lockout for low temperatures ** See page 11 3 Lockout for high and low temperatures ** See page 11
0431 Ventilation high temperature lockout	100 100°F (38°C): Settings 5°F apart (3°C) [Other options: (90°F to 110°F/32°C to 43.5°C)]
0432 Ventilation low temperature lockout	-10 -10°F (-23.5°C): Settings 5°F apart (3°C) [Other options: (-20°F to 0°F/-29°C to -18°C)]
0500 Furnace filter change reminder	0 Off 8 365-day run time 1 10-day run time 9 30 calendar days 2 30-day run time 10 60 calendar days 3 60-day run time 11 90 calendar days 4 90-day run time 12 120 calendar days 5 120-day run time 13 180 calendar days 6 180-day run time 14 365 calendar days 7 270-day run time
0502 Furnace filter alert options	0 Timer counts Heat & Cool run time 1 Timer counts Cool run time only
0510 Humidifier pad change reminder	0 Off 1 90 calendar days 2 180 calendar days 3 365 calendar days
0520 UV lamp change reminder	0 Off 1 1 year 2 2 years

Continued on next page

Installer setup

Setup functions	Settings & Options (factory default in bold)
0530 Adaptive Intelligent Recovery™	1 On ** See page 11 0 Off
0540 Program periods	4 4 program periods (Wake, Leave, Return, Sleep) 2 2 program periods (Wake, Sleep)
0580 Compressor protection	5 5 minute compressor off time ** See page 11 [Other options: 0, 1, 2, 3 or 4-minute off time]
0600 Heat temperature range stop	90 Max. heat temperature setting is 90°F (32°C) [Other options: 40-89°F (4°C to 32°C)]
0610 Cool temperature range stop	50 Min. cool temperature setting is 50°F (10°C) [Other options: 51-99°F (11°C to 37°C)]
0640 Clock format	12 12-hour time (i.e., "3:30 pm") 24 24-hour time (i.e., "15:30")
0650 Extended fan timer (heat)	0 Off [Other options: Fan runs for 30, 60, 90, or 120 seconds after call for heat ends]
0660 Extended fan timer (cool)	0 Off [Other options: Fan runs for 30, 60, 90, or 120 seconds after call for cool ends]
0670 Keypad lock	0 Keypad unlocked (fully functional) 1 Partially locked (access to temperature settings only) 2 Fully locked
0680 Heat temperature control	2 Standard temperature control (recommended) 1 Choose if room is warmer than set temperature 3 Choose if room does not reach set temperature
0690 Cool temperature control	2 Standard temperature control (recommended) 1 Choose if room is cooler than set temperature 3 Choose if room does not reach set temperature
0700 Temperature display offset	0 Thermostat displays actual room temperature [Other options: -3, -2, -1, 1, 2, 3°F offset (-1.5°C to 1.5°C)]
0701 Humidity display offset	0 0% [Other options: -12% to 12%]
0710 RESET	0 No reset 1 Reset installer options & program schedule to factory default (only date and time settings are retained)

Installer system test

During installer setup, press ▼ repeatedly until "Test" appears.

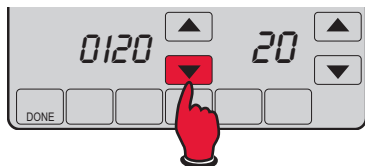

Press DONE to terminate testing.

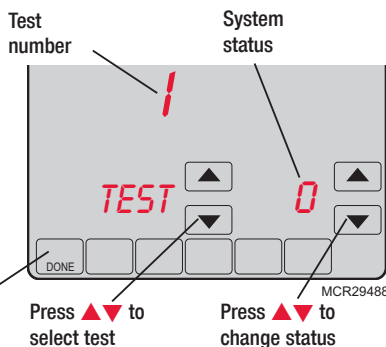

Press ▲▼ to select test

Press ▲▼ to change status

Installer system test

System test

1 Cooling system

2 Fan system

3 Heating system

4 Emergency heating system

5 Humidifier

6 Dehumidifier

7 Ventilator

System status

0	Compressor and fan turn off
1	Compressor and fan turn on
2	Second stage compressor turns on
0	Fan turns off
1	Fan turns on
0	Heat and fan turn off
1	Heat turns on (fan on if Function 0170 is set for heat pump, or if Function 0180 is set to "1") ** See page 6
2	Second stage heat turns on
3	Third stage heat turns on
0	Heat and fan turn off
1	Heat and fan turn on
0	Off
1	Humidifier on
0	Off
1	Dehumidifier on
0	Off
1	Ventilator on



CAUTION: EQUIPMENT DAMAGE HAZARD.

Compressor protection is bypassed during testing. To prevent equipment damage, avoid cycling the compressor quickly.

Special functions

Auto Changeover (Setup Function 0300): When set to Auto, the thermostat automatically selects heating or cooling depending on the indoor temperature. Heat and cool settings must be at least 2 degrees apart. If function 0380 is set to On, the heat and cool settings must be at least 5 degrees apart.

Remote Sensor (Setup Function 0340): If an optional outdoor sensor is installed, the thermostat can display the outside temperature. If an optional remote indoor sensor is installed, the thermostat will display the temperature at the sensor location (the internal sensor in the thermostat is not used). A Discharge Air Temperature Sensor (DATS) is required to enable desert humidification.

Adaptive Intelligent Recovery (Setup Function 0530): Allows the thermostat to "learn" how long the furnace and air conditioner take to reach programmed temperature settings, so the temperature is reached at the scheduled time.

Compressor Protection (Setup Function 0580): Forces the compressor to wait a few minutes before restarting, to prevent damage. During this time, the message "Wait" is displayed.

Dehumidification control (Setup Function 0380): TH8321 models monitor the indoor humidity level and automatically activate the cooling system to reduce humidity by lowering the temperature by up to 3 degrees below the current cool setting. When Setup Function 0371 is set to dehumidification, the U1/U1 relay can be set to control dehumidification.

Heat Pump Control — Electric Backup (Setup Functions 0350-0360): If an outdoor temperature sensor is installed, select a compressor lockout temperature (Function 0350). Below this temperature, only electric heat operates. Also select an auxiliary lockout temperature (Function 0360). Above this temperature, only the compressor operates. Between these temperatures, both heat sources operate.

Heat Pump Control — Fossil Fuel Backup (Setup Function 0345):

Option 0 (No Droop Control): If outdoor temperature is above balance point (Function 0350), only the compressor operates. Below this temperature, only backup heat operates.

Option 1 (Droop Control): As above, but backup heat is activated if room temperature drops to the selected droop temperature setting (compressor is deactivated).

Option 2: (Droop Control with Aux Heat lockout): Compressor works only above auxiliary lockout temperature, backup heat works only below balance point, 2° droop between temperatures.

If temperature is not reached in a reasonable time, set the **upstage timer** (Function 0346). After the designated time, the compressor will be deactivated and the system will switch to backup heat.

Ventilation Control (Setup Functions 0400-0432): If the system includes a self-powered ventilation unit (Function 0400), the home can be ventilated on demand. Ventilation can also be locked out based on high and low outdoor temperature (Function 0431 & 0432)—outdoor temperature sensor required.

Dehumidification Away Mode (Setup Functions 0390-0394): This feature is useful for homes in southern climates. It allows humidity control when the the home is unoccupied for long periods during the hot/humid season. You can control temperature (Function 0393) and dehumidification (Function 0394) while away. You can control humidity with a dehumidifier or a cooling system (Function 0379). If a cooling system is used, humidity is controlled by cooling indoor air to the Low Limit Temperature (Function 0392). When the desired humidity is reached, the system will maintain the temperature you select in Function 0393.

Indoor Air Quality Device (Setup Function 0371): This feature allows the thermostat to control one of the following IAQ devices: whole house humidifier, dehumidifier, or ventilator.

Accessories & replacement parts

Please contact your distributor to order replacement parts.

Outdoor temperature sensor	Part Number C7089U1006
Remote indoor temperature sensor	Part Number C7189U1005
Discharge air temperature sensor	Part Number C7735A1000
Energy recovery ventilator	Part number ER200B2006
Heat recovery ventilator	Part number HR200B1005
Fresh air damper	Part number EARD6
Bypass flow through humidifier	Part number HE265A1007
TrueSTEAM humidifier	Part number HM512W1005
Cover plate*	Part Number 32003796-001

*(Use to cover marks left by old thermostats.)

Specifications

Temperature Ranges

- Heat: 40° to 90°F (4.5° to 32°C)
- Cool: 50° to 99°F (10° to 37°C)

Operating Ambient Temperature

- 0° to 120°F (-18° to 48.9°C)

Shipping Temperature

- -30° to 150°F (-34° to 66°C)

Operating Relative Humidity

- 5% to 90% (non-condensing)

Physical Dimensions

- 4-9/16" H x 6" W x 1-3/8" D
- 116 mm H x 152 mm W x 35 mm D

Electrical Ratings

Terminal	Voltage (50/60Hz)	Running Current
W Heating (Powerpile)	20-30 Vac 750 mV DC	0.02-1.0 A 100 mA DC
W2 Heating	20-30 Vac	0.02-0.6 A
Y Cooling	20-30 Vac	0.02-1.0 A
Y2 Cooling	20-30 Vac	0.02-0.6 A
E/Aux Auxiliary/ Emergency heat	20-30 Vac	0.02-1.0 A
O/B Changeover	20-30 Vac	0.02-0.6 A
L Heat pump reset	20-30 Vac	0.02-0.6 A
U1/U1 IAQ relay	20-30 Vac	0.02-0.6 A

Automation and Control Solutions

Honeywell International Inc.

1985 Douglas Drive North

Golden Valley, MN 55422

<http://yourhome.honeywell.com>

Honeywell Limited-Honeywell Limitée

35 Dynamic Drive

Toronto, Ontario M1V 4Z9

Honeywell

© U.S. Registered Trademark.

US Patent No. 6595430, D509151 and other patents pending.

© 2011 Honeywell International Inc.

69-2389—03 M.S. Rev 03-11

Printed in U.S.A.